

Display Joysticks

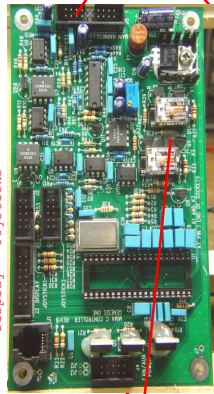

Mima fan and power switching ribbon  
 Chassis ground  
 MIMA Console 5V  
 5V SPDT  
 13.6V source

Mima Harness Ribbon  
 10- BLACK  
 9- WHITE  
 11- BROWN  
 14- YELLOW  
 19- GREEN  
 3- ORANGE

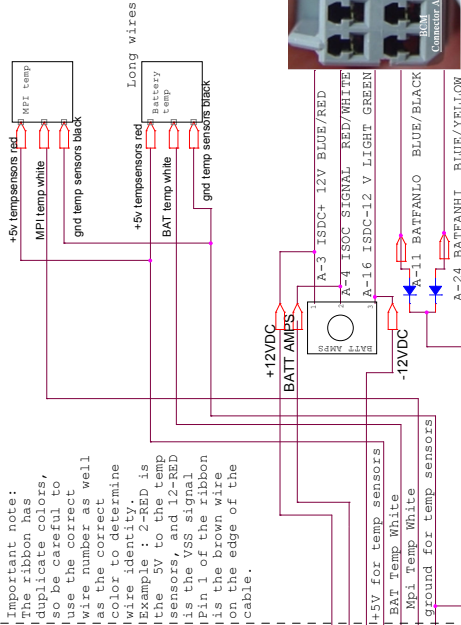

Important note:  
 The ribbon has duplicate colors, so be careful to use the correct wire number as well as the correct color to determine wire identity.  
 Example: 12-RED is the VSS signal, and 12-BLUE is the brown wire on the edge of the cable.

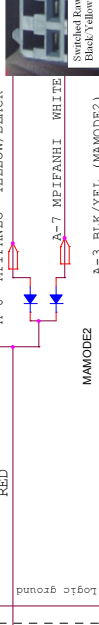

13- ORANGE  
 18- GRAY  
 17- VIOLET  
 16- BLUE  
 20- BLACK  
 19- WHITE

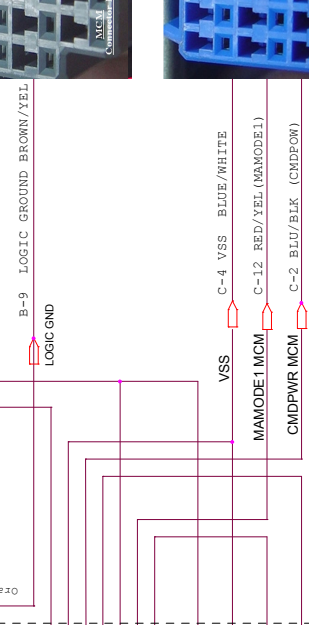

Shift console area No splices

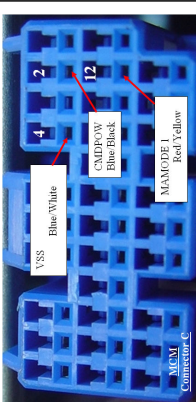
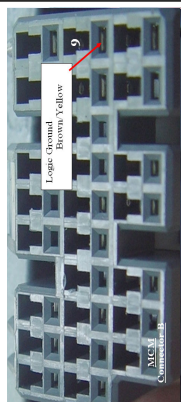
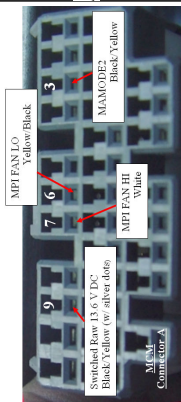
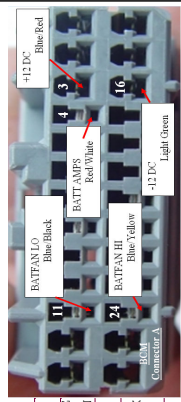

Rear MCM and BCM connections level 1 install

Front ECM connections Level 2 install

Rev	1	of	2
Issue	1	of	1
Doc No	MIMA Connection Drawing		
Doc Desc	MIMA Console Harness for units 9 and up		
Doc Date	Monday, November 14, 2005	Page	2